

**SHOREY
PRECAST
CONCRETE
PRODUCTS**

**LOW PROFILE
SEPTIC TANK
9,000 GALLON (H-20)
ST-LOW-9000-H-20**

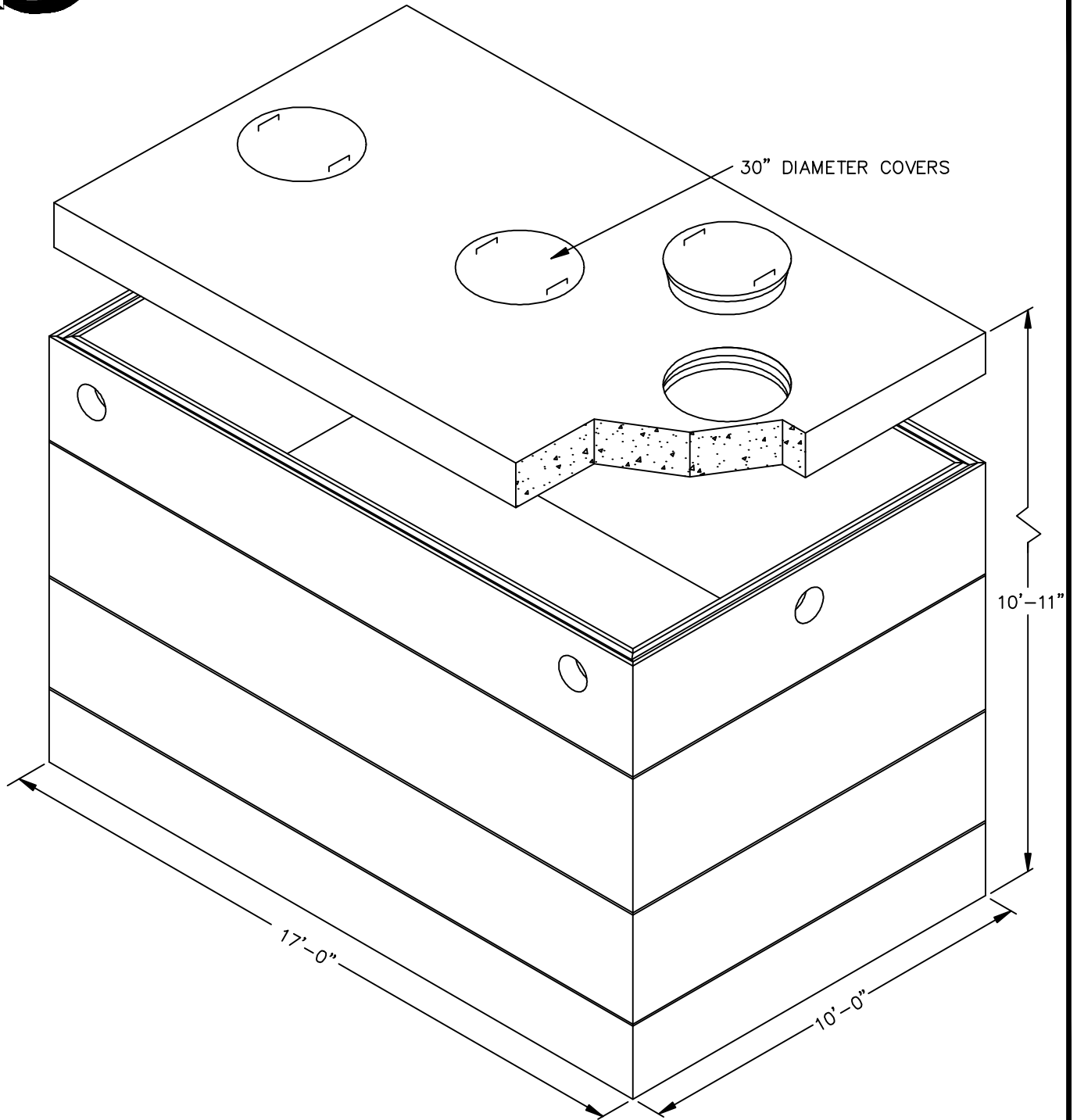

SHOREY PRECAST CONCRETE PRODUCTS

351 Whites Path
S. Yarmouth, MA 02664
(800) 439-0965 • (508) 760-1070