

**SHOREY  
PRECAST  
CONCRETE  
PRODUCTS**

**SEPTIC TANK  
5,500 GALLON (H-20)  
ST-5500-H-20**

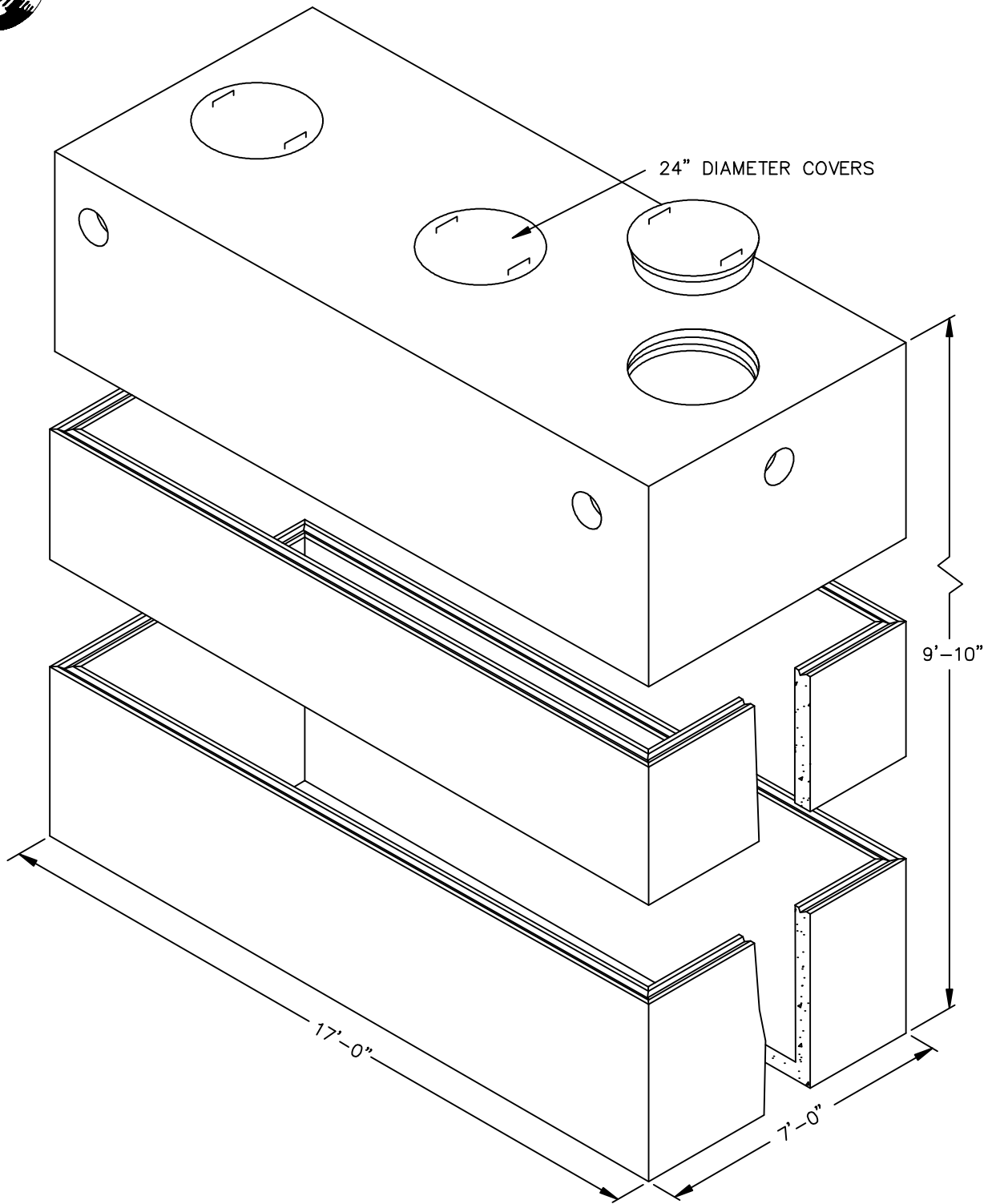

**SHOREY PRECAST CONCRETE PRODUCTS**

351 Whites Path

S. Yarmouth, MA 02664

(800) 439-0965 • (508) 760-1070